

**H** SISTEMA / SYSTEM

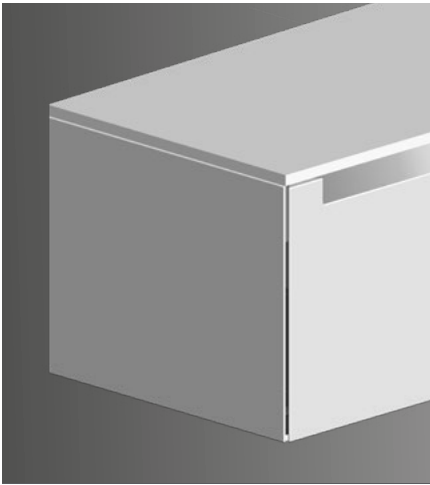

CI  
 Costado Ingletado  
 Mitred sides  
 Côté coupe en onglet  
 Fiancone con angolo  
 Seitenelement mit gehrung  
 Боковая сторона, соединенная под углом



U3A  
 Uñero Superior en inglete  
 Top opening  
 Poignée cuvette supérieure  
 Apertura superiore  
 Daumenloch oben  
 Ручка фрезерованная верхняя со срезом

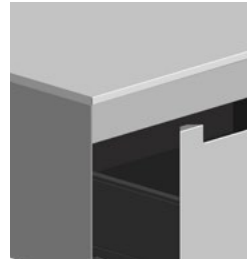

1 Cajón / 1 Drawer

U3A

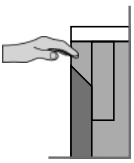

2 Cajones / 2 Drawers

U3A

U3C

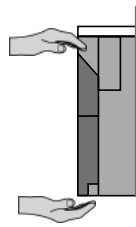

ACABADOS / FINISHES / FINITIONS / FINITURE / OBERFLÄCHENAUSFÜHRUNG / ОТДЕЛК

ES Por defecto los módulos vienen con tapa simple y barramento en el acabado escogido, si se desea cambiar el acabado de la tapa y/o barramento será necesario añadir estos elementos aparte en el acabado deseado. Como excepción, los módulos en acabado MDi no incluyen tapa, será necesario siempre añadir una tapa aparte en el acabado deseado.

EN By default, the modules come with a simple top and bar in the chosen finish. If you want to change the finish of the top and / or bar, the desired finish can be added separately. As an exception, the modules with an MDi finish do not include a cover, so a cover in the desired finish will always have to be added.

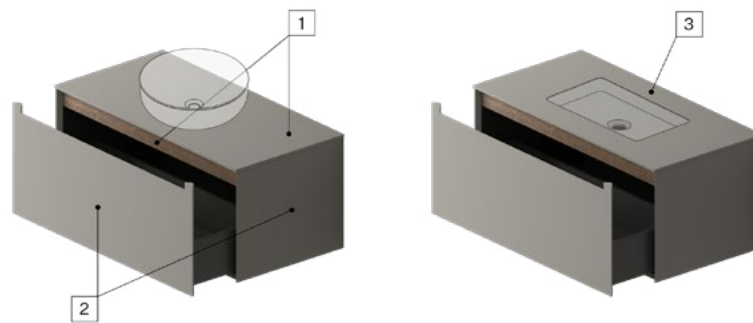

- 1** Corian  
 Solidsurface  
 UHS Color / UHS Colour  
 Mármol / Marble (MP, MC, MN)  
 CB - Cristal Brillo / Glossy glass  
 CM - Cristal Mate/ Matt glass  
 LM - Laca Mate / Matt Lacquer  
 LT - Laca Texturizada / Textured Lacquer  
 LB - Laca Brillo / Glossy Lacquer  
 S1 - Madera Natural / Natural wood  
 S3 - Roble salvaje / Wild oak  
 S4 - Roble Raw / Raw oak  
 MDi

- 2** LM - Laca Mate / Matt Lacquer  
 LT - Laca Texturizada / Textured Lacquer  
 LB - Laca Brillo / Glossy Lacquer  
 S3 - Roble salvaje / Wild oak  
 S4 - Roble Raw / Raw oak  
 MDi

- 3** Corian  
 Solidsurface  
 UHS Color / UHS Colour  
 Mármol / Marble (MP, MC, MN)  
 MDi

- ES** Por defecto los pedidos de referencias independientes se fabrican como en su respectiva imagen representativa, cerrados con tapa simple, íntegramente en el acabado escogido. Si desea que el módulo quede abierto por arriba debe indicarlo. Para cambiar el acabado de la tapa o barramento/s deberá añadir esta referencia aparte. Para añadir tapa con lavabo/s integrado/s deberá añadir esta referencia aparte. Para realizar modulaciones entre distintas referencias deberá añadir al pedido las distintas referencias de la modulación así como una tapa de cierre simple o con lavabo/s en el acabado deseado y de la medida L total correspondiente al total de la modulación. Cuando se realizan modulaciones entre distintas referencias la construcción de los módulos será modificada en los puntos de unión de manera que el aspecto final de la composición sea el determinado por el sistema. Las composiciones de módulos inferiores a L180 cm podrán ser convertidas a módulos compactos y se enviarán montadas en una sola pieza. Para módulos abiertos ubicados en los extremos de la composición, opcionalmente puede añadir lateral/es decorativo/s para el cierre de la misma.
- EN** By default, orders for independent items are manufactured as seen in the photo using a simple cover, entirely in the chosen finish. If you want the module to be open at the top, please let us know. To change the finish of the top or bar / s, please add the item. A lid with an integrated basin / s has to be added separately. To make modules from different references, each one must be added to the order, such as a single closing lid or a washbasin / s in the desired finish, and the total L measurement will correspond to the entire module. When modules are made up using different references, the construction of the modules is modified at the joints so that the final appearance of the composition is determined by the system. The compositions of modules smaller than L180 cm can be converted to compact modules and will be shipped ready-assembled in a single piece. For modules located at the ends of the composition, decorative side(s) must be included to finish it off.
- FR** Par défaut, les commandes de références indépendantes sont fabriquées comme sur leur image représentative respective, fermées par un simple plateau, entièrement dans la finition choisie. Si vous souhaitez que le module soit ouvert sur le dessus, vous devez le préciser. Pour changer la finition du plateau ou de la/des barre/s, vous devrez ajouter cette référence à part. Pour ajouter un plateau avec vasque/s intégrée(s), vous devrez ajouter cette référence à part. Pour effectuer des modulations entre différentes références, les différentes références de la modulation devront être ajoutées à la commande, ainsi qu'un plateau simple ou avec lavabo/s dans la finition souhaitée et de taille L totale correspondant à la modulation totale. Lorsque des modulations sont faites entre différentes références, la construction des modules sera modifiée aux points de jonction pour que l'aspect final de la composition soit déterminé par le système. Les compositions de modules inférieurs à L180 cm pourront être converties en modules compactes et seront expédiées assemblées en une seule pièce. Pour les modules ouverts situés aux extrémités de la composition, vous devez ajouter un/des côté(s) décoratif(s) pour le fermer.
- IT** Per default, gli ordini di articoli indipendenti sono fabbricati come si vede nella foto con una semplice copertura, interamente nella finitura scelta. Se vuoi che il modulo sia aperto nella parte superiore, ti preghiamo di farcelo sapere. Per cambiare la finitura del piano o della barra / s, si prega di aggiungere l'articolo. Un coperchio con una vasca integrata / s deve essere aggiunto separatamente. Per comporre i moduli a partire da diverse referenze, occorre aggiungere all'ordine ognuna di esse, come un singolo coperchio di chiusura o un lavabo / s nella finitura desiderata, e la misura totale L corrisponderà all'intero modulo. Quando i moduli vengono composti con riferimenti diversi, la costruzione dei moduli viene modificata nelle giunzioni in modo che l'aspetto finale della composizione sia determinato dal sistema. Le composizioni di moduli più piccoli di L180 cm possono essere convertite in moduli compatti e saranno spedite già assemblate in un unico pezzo. Per i moduli situati alle estremità della composizione, è necessario includere uno o più lati decorativi per rifinirla.
- GE** Standardmäßig werden Bestellungen für eigenständige Artikel wie auf dem Foto zu sehen mit einem einfachen Deckel, ganz in der gewählten Ausführung, gefertigt. Wenn Sie das Modul an der Spitze offen sein soll, lassen Sie es uns bitte wissen. Um die Ausführung des Deckels oder der Bar / s zu ändern, fügen Sie bitte den Artikel hinzu. Ein Deckel mit einem integrierten Becken / s muss separat hinzugefügt werden. Um Module aus verschiedenen Referenzen zu machen, muss jeder der Bestellung hinzugefügt werden, wie z. B. eine einzelne Schließdeckel oder ein Waschbecken / s in der gewünschten Ausführung, und die gesamte L-Messung wird auf das gesamte Modul entsprechen. Bei der Zusammenstellung von Modulen mit verschiedenen Referenzen wird die Konstruktion der Module an den Verbindungsstellen geändert, so dass das endgültige Aussehen der Zusammensetzung durch das System bestimmt wird. Die Zusammenstellungen von Modulen, die kleiner als L180cm sind, können in Kompaktmodule umgewandelt werden und werden in einem Stück fertig montiert geliefert. Für Module, die sich an den Enden der Komposition befinden, müssen dekorative Seiten hinzugefügt werden, um die Komposition abzuschließen.
- RU** По умолчанию заказы на независимые изделия изготавливаются, как показано на фотографии, с использованием простой крышки, полностью в выбранной отделке. Если вы хотите, чтобы модуль был открыт сверху, пожалуйста, сообщите нам об этом. Чтобы изменить отделку верха или планки / с, пожалуйста, добавьте этот элемент. Крышка со встроенной раковиной / с должна быть добавлена отдельно. Для составления модулей из разных артикулов, каждый из них должен быть добавлен к заказу, например, одна закрывающаяся крышка или умывальник / с в желаемой отделке, и общее измерение L будет соответствовать всему модулю. При составлении модулей с использованием различных эталонов конструкция модулей изменяется на стыках, так что окончательный вид композиции определяется системой. Композиции из модулей размером менее L180 см могут быть преобразованы в компактные модули и будут поставяться в собранном виде. Для модулей, расположенных на концах композиции, необходимо включить декоративную сторону (стороны), чтобы завершить ее.

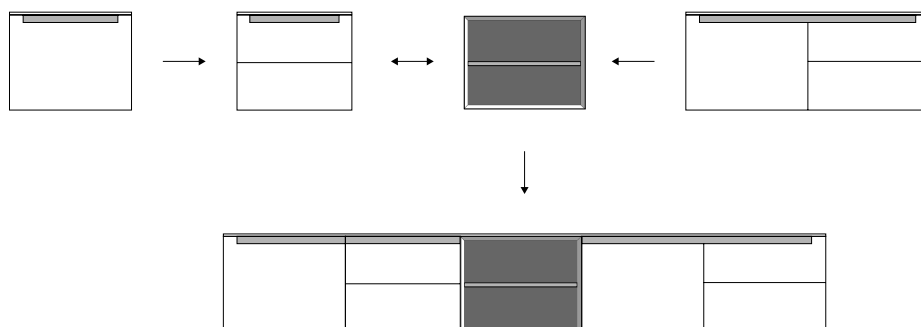

Para barramento en distinto acabado del mueble añadir aparte. / For upper inner front in a different finish of the furniture add separately. / Partie frontale en différente finition, à rajouter. / Struttura frontale interno superiore in una diversa finitura del mobile aggiungere a parte. / Für Frontschürze innen sichtbar in einem anderen Finish der Möbel separat hinzufügen. / Для верхнего внутреннего фасада в другой отделке мебели добавить отдельно.

Barramento / Upper inner front / Traverse / Struttura frontale / Frontschürze innen:



| Cod.  | L   | Corian®<br>Solidsurface | MN<br>MC/MP | UHS | LM/LT/LB | S1/S3/S4 | MDi |
|-------|-----|-------------------------|-------------|-----|----------|----------|-----|
| BP104 | 40  |                         |             |     |          |          |     |
| BP106 | 60  |                         |             |     |          |          |     |
| BP108 | 80  |                         |             |     |          |          |     |
| BP110 | 100 |                         |             |     |          |          |     |
| BP112 | 120 |                         |             |     |          |          |     |
| BP114 | 140 |                         |             |     |          |          |     |
| BP116 | 160 |                         |             |     |          |          |     |
| BP118 | 180 |                         |             |     |          |          |     |
| BP120 | 200 |                         |             |     |          |          |     |
| BP122 | 220 |                         |             |     |          |          |     |

Tapas / Tops:

Ver precios de Tapas Simples en págs. 318-319 de Tarifa n14. / See prices of Simple Tops on pages 318-319 of Price List n14.

Ver precios de Tapas con lavabo integrado en págs. 320-321 de Tarifa n14. / See prices of Tops with integrated washbasins on pages 320-321 of Price List n14.

LM Laca Mate / Matt Lacquer / Laqué Mat / Laccato Opaco / Mattlack / Матовый лак  
 LT Laca Texturizada / Textured Lacquer / Laqué Texturé / Laccato Testurizzato / Strukturlack / Текстурированный лак  
 LB Laca Brillo / Glossy Lacquer / Laqué Brillant / Lacca Lucida / Glanzlack / Глянцевая медь  
 S1 Madera natural / Natural wood / Bois Naturel / Legno Naturale / Echtholz / Натуральное дерево  
 S3 Roble salvaje / Wild oak / Chêne sauvage / Rovere selvaggio / Natureiche / Дикая дуб

S4 Roble Raw / Raw oak / Chêne Raw / Rovere Raw / Roheiche / Raw дуб  
 MN Mármol Marquina / Marquina Marble / Marbre Marquina / Marmo di Marquina / Marquina-Marmor / Мрамор  
 MC Mármol Carrara / Carrara Marble / Marbre Carrara / Marmo di Carrara / Carrara-Marmor / Каррарский мрамор  
 MP Mármol Pietra Grey / Pietra Grey Marble / Marbre Pietra Grey / Marmo Pietra Grey / Pietra Grey Marmor / Мрамор

CONFIGURACIONES / CONFIGURATIONS

Módulos individuales / Individual units



H30 cm · L30-140 cm



H45 cm · L30-110 cm  
H60 cm · L30-110 cm

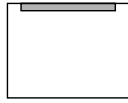

H30 cm · L30-120 cm  
H45 cm · L30-120 cm  
H60 cm · L40-100 cm

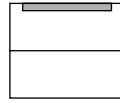

H45 cm · L30-120 cm  
H60 cm · L40-120 cm

Módulos compactos / Compact units

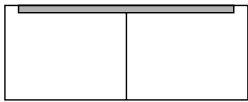

H30 cm · L80-220 cm  
H45 cm · L80-220 cm  
H60 cm · L80-220 cm

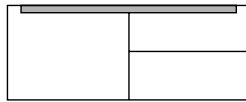

H45 cm · L80-220 cm  
H60 cm · L80-220 cm

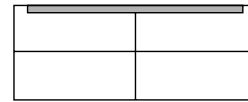

H45 cm · L80-220 cm  
H60 cm · L80-220 cm



H45 cm · L120-220 cm  
H60 cm · L120-220 cm

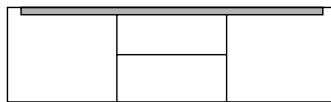

H45 cm · L120-220 cm  
H60 cm · L120-220 cm

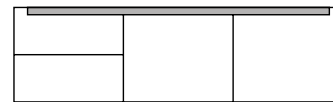

H45 cm · L120-220 cm  
H60 cm · L120-220 cm

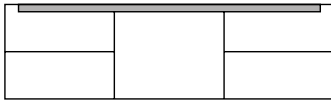

H45 cm · L120-220 cm  
H60 cm · L120-220 cm

Módulos con puerta

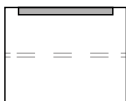

H 45/60 cm  
L 30 - 60 cm

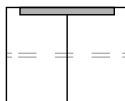

H 45/60 cm  
L 60 - 120 cm

ES Módulo suspendido abierto. Para modular con cajones y puertas.

IT Modulo sospeso aperto. Per modulare con cassetti e porte.

EN Wall mounted open unit. To be combined with doors and drawers units.

GE Offenes Hängemodul aus Metall. Für die Ergänzung mit Schubladen- und Türmodulen.

FR Niche à suspendre ouvert. À combiner avec tiroirs et portes.

RU Подвесной открытый модуль. Дополняется ящиками и дверцами.

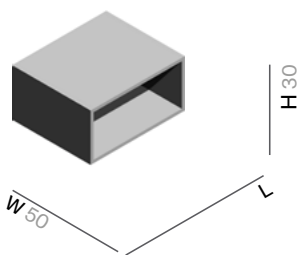

| Cod.   | H  | L   | LM/LT | LB | S1 | S3/S4 |
|--------|----|-----|-------|----|----|-------|
| ST952  | 30 | 30  |       |    |    |       |
| ST1233 | 30 | 45  |       |    |    |       |
| ST234  | 30 | 60  |       |    |    |       |
| ST953  | 30 | 80  |       |    |    |       |
| ST954  | 30 | 100 |       |    |    |       |
| ST955  | 30 | 120 |       |    |    |       |
| ST956  | 30 | 140 |       |    |    |       |

ES Módulo abierto suspendido o al suelo con un estante.

IT Modulo aperto sospeso o al pavimento con un ripiano.

EN Wall mounted / floor standing open unit with shelf.

GE Offenes Hänge- oder Bodenmodul. Mit Regalbodens.

FR Niche ouverte à suspendre ou au sol avec étagère.

RU Внешняя подвеска или напольный модуль. С полкой.

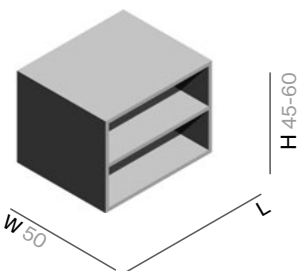

| Cod.  | H  | L   | LM/LT | LB | S1 | S3/S4 |
|-------|----|-----|-------|----|----|-------|
| ST201 | 45 | 30  |       |    |    |       |
| ST202 | 45 | 40  |       |    |    |       |
| ST203 | 45 | 60  |       |    |    |       |
| ST204 | 45 | 80  |       |    |    |       |
| ST957 | 45 | 90  |       |    |    |       |
| ST958 | 45 | 100 |       |    |    |       |
| ST959 | 45 | 110 |       |    |    |       |
| ST206 | 60 | 30  |       |    |    |       |
| ST207 | 60 | 40  |       |    |    |       |
| ST208 | 60 | 60  |       |    |    |       |
| ST209 | 60 | 80  |       |    |    |       |
| ST983 | 60 | 90  |       |    |    |       |
| ST984 | 60 | 100 |       |    |    |       |
| ST985 | 60 | 110 |       |    |    |       |

LM Laca Mate / Matt Lacquer / Laqué Mat / Laccato Opaco / Mattlack / Матовый лак

S1 Madera natural / Natural wood / Bois Naturel / Legno Naturale / Echtholz / Натуральное дерево

LT Laca Texturizada / Textured Lacquer / Laqué Texturé / Laccato Testurizzato / Strukturlack / Текстурированный лак

S3 Roble salvaje / Wild oak / Chêne sauvage / Rovere selvaggio / Natureiche / Дикая дуб

LB Laca Brillo / Glossy Lacquer / Laqué Brillant / Lacca Lucida / Glanzlack / Глянцевая медь

S4 Roble Raw / Raw oak / Chêne Raw / Rovere Raw / Roheiche / Raw дуб

ES Módulo suspendido o al suelo con cajón.

IT Modulo sospeso / al pavimento con cassetto.

EN Wall mounted or floor standing unit with drawer.

GE Hänge- oder Bodenmodul mit Schublade.

FR Meuble à suspendre / au sol avec tiroir.

RU Подвесной или напольный модуль с ящиком.

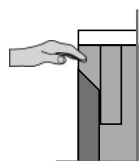
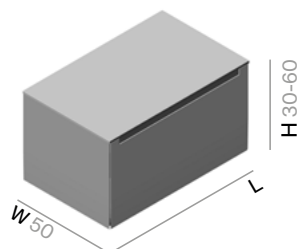

| Cod.  | H  | L   | LM/LT | LB | S3/S4 | MDi |
|-------|----|-----|-------|----|-------|-----|
| ST731 | 30 | 30  |       |    |       |     |
| ST732 | 30 | 40  |       |    |       |     |
| ST733 | 30 | 60  |       |    |       |     |
| ST734 | 30 | 80  |       |    |       |     |
| ST735 | 30 | 100 |       |    |       |     |
| ST747 | 30 | 120 |       |    |       |     |
| ST322 | 45 | 30  |       |    |       |     |
| ST312 | 45 | 40  |       |    |       |     |
| ST316 | 45 | 60  |       |    |       |     |
| ST319 | 45 | 80  |       |    |       |     |
| ST701 | 45 | 100 |       |    |       |     |
| ST773 | 45 | 120 |       |    |       |     |
| ST727 | 60 | 40  |       |    |       |     |
| ST728 | 60 | 60  |       |    |       |     |
| ST729 | 60 | 80  |       |    |       |     |
| ST730 | 60 | 100 |       |    |       |     |



Para barramento en distinto acabado del mueble añadir aparte. / For upper inner front in a different finish of the furniture add separately. / Partie frontale en différente finition, à rajouter. / Struttura frontale interno superiore in una diversa finitura del mobile aggiungere a parte. / Für Frontschürze innen sichtbar in einem anderen Finish der Möbel separat hinzufügen. / Для верхнего внутреннего фасада в другой отделке мебели добавить отдельно.

| Cod.  | L   | Corian®<br>Solidsurface | MN<br>MC/MP | UHS | LM/LT/LB | S1/S3/S4 | MDi |
|-------|-----|-------------------------|-------------|-----|----------|----------|-----|
| BP104 | 40  |                         |             |     |          |          |     |
| BP106 | 60  |                         |             |     |          |          |     |
| BP108 | 80  |                         |             |     |          |          |     |
| BP110 | 100 |                         |             |     |          |          |     |
| BP112 | 120 |                         |             |     |          |          |     |

LM Laca Mate / Matt Lacquer / Laqué Mat / Laccato Opaco / Mattlack / Матовый лак

S4 Roble Raw / Raw oak / Chêne Raw / Rovere Raw / Roheiche / Raw дуб

LT Laca Texturizada / Textured Lacquer / Laqué Texturé / Laccato Testurizzato / Strukturlack / Текстурированный лак

MN Marmor Marquina / Marquina Marble / Marbre Marquina / Marmo di Marquina / Marquina-Marmor / Мрамор

LB Laca Brillo / Glossy Lacquer / Laqué Brillant / Lacca Lucida / Glanzlack / Глянцевая медь

MC Marmor Carrara / Carrara Marble / Marbre Carrara / Marmo di Carrara / Carrara-Marmor / Каррарский мрамор

S1 Madera natural / Natural wood / Bois Naturel / Legno Naturale / Echtholz / Натуральное дерево

MP Marmor Pietra Grey / Pietra Grey Marble / Marbre Pietra Grey / Marmo Pietra Grey / Pietra Grey Marmor / Мрамор

S3 Roble salvaje / Wild oak / Chêne sauvage / Rovere selvaggio / Natureiche / Дикая дуб

ES Módulo suspendido o al suelo con dos cajones.

IT Modulo sospeso o al pavimento con due cassetti.

EN Wall mounted or floor standing unit with two drawers.

GE Hänge- oder Bodenmodul mit zwei Schubladen.

FR Meuble à suspendre ou au sol avec deux tiroirs.

RU Подвесной или напольный модуль с двумя ящиками.

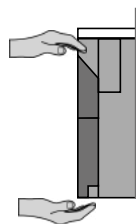
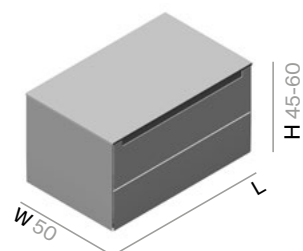

| Cod.  | H  | L   | LM/LT | LB | S3/S4 | MDi |
|-------|----|-----|-------|----|-------|-----|
| ST337 | 45 | 30  |       |    |       |     |
| ST325 | 45 | 40  |       |    |       |     |
| ST327 | 45 | 60  |       |    |       |     |
| ST329 | 45 | 80  |       |    |       |     |
| ST702 | 45 | 100 |       |    |       |     |
| ST746 | 45 | 120 |       |    |       |     |
| ST707 | 60 | 40  |       |    |       |     |
| ST708 | 60 | 60  |       |    |       |     |
| ST709 | 60 | 80  |       |    |       |     |
| ST712 | 60 | 100 |       |    |       |     |
| ST761 | 60 | 120 |       |    |       |     |



Para barramento en distinto acabado del mueble añadir aparte. / For upper inner front in a different finish of the furniture add separately. / Partie frontale en différente finition, à rajouter. / Struttura frontale interno superiore in una diversa finitura del mobile aggiungere a parte. / Für Frontschürze innen sichtbar in einem anderen Finish der Möbel separat hinzufügen. / Для верхнего внутреннего фасада в другой отделке мебели добавить отдельно.

| Cod.  | L   | Corian®<br>Solidsurface | MN<br>MC/MP | UHS | LM/LT/LB | S1/S3/S4 | MDi |
|-------|-----|-------------------------|-------------|-----|----------|----------|-----|
| BP104 | 40  |                         |             |     |          |          |     |
| BP106 | 60  |                         |             |     |          |          |     |
| BP108 | 80  |                         |             |     |          |          |     |
| BP110 | 100 |                         |             |     |          |          |     |
| BP112 | 120 |                         |             |     |          |          |     |

LM Laca Mate / Matt Lacquer / Laqué Mat / Laccato Opaco / Mattlack / Матовый лак

S4 Roble Raw / Raw oak / Chêne Raw / Rovere Raw / Roheiche / Raw дуб

LT Laca Texturizada / Textured Lacquer / Laqué Texturé / Laccato Testurizzato / Strukturlack / Текстурированный лак

MN Marmor Marquina / Marquina Marble / Marbre Marquina / Marmo di Marquina / Marquina-Marmor / Мрамор

LB Laca Brillo / Glossy Lacquer / Laqué Brillant / Lacca Lucida / Glanzlack / Глянцевая медь

MC Marmor Carrara / Carrara Marble / Marbre Carrara / Marmo di Carrara / Carrara-Marmor / Каррарский мрамор

S1 Madera natural / Natural wood / Bois Naturel / Legno Naturale / Echtholz / Натуральное дерево

MP Marmor Pietra Grey / Pietra Grey Marble / Marbre Pietra Grey / Marmo Pietra Grey / Pietra Grey Marmor / Мрамор

S3 Roble salvaje / Wild oak / Chêne sauvage / Rovere selvaggio / Natureiche / Дикая дуб

ES Módulo compacto suspendido o al suelo con dos cajones.

IT Modulo compatto sospeso o al pavimento con due cassetti.

EN Wall mounted or floor standing unit with two drawers.

GE Kompaktes Hänge- oder Bodenmodul mit zwei Schubladen.

FR Meuble à suspendre ou au sol avec deux tiroirs.

RU Подвесной или напольный компактный модуль с двумя ящиками.

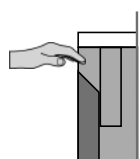
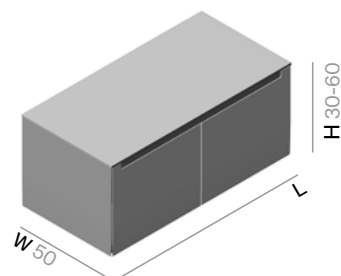

| Cod.   | H  | L   | LM/LT | LB | S3/S4 | MDi |
|--------|----|-----|-------|----|-------|-----|
| ST767  | 30 | 80  |       |    |       |     |
| ST768  | 30 | 100 |       |    |       |     |
| ST769  | 30 | 120 |       |    |       |     |
| ST770  | 30 | 140 |       |    |       |     |
| ST771  | 30 | 160 |       |    |       |     |
| ST772  | 30 | 180 |       |    |       |     |
| ST1049 | 30 | 200 |       |    |       |     |
| ST1050 | 30 | 220 |       |    |       |     |
| ST500  | 45 | 80  |       |    |       |     |
| ST705  | 45 | 100 |       |    |       |     |
| ST706  | 45 | 120 |       |    |       |     |
| ST744  | 45 | 140 |       |    |       |     |
| ST745  | 45 | 160 |       |    |       |     |
| ST756  | 45 | 180 |       |    |       |     |
| ST1051 | 45 | 200 |       |    |       |     |
| ST1052 | 45 | 220 |       |    |       |     |
| ST786  | 60 | 80  |       |    |       |     |
| ST788  | 60 | 100 |       |    |       |     |
| ST789  | 60 | 120 |       |    |       |     |
| ST790  | 60 | 140 |       |    |       |     |
| ST791  | 60 | 160 |       |    |       |     |
| ST792  | 60 | 180 |       |    |       |     |
| ST1069 | 60 | 200 |       |    |       |     |
| ST1070 | 60 | 220 |       |    |       |     |

Para barramento en distinto acabado del mueble añadir aparte. / For upper inner front in a different finish of the furniture add separately. / Partie frontale en différente finition, à rajouter. / Struttura frontale interno superiore in una diversa finitura del mobile aggiungere a parte. / Für Frontschürze innen sichtbar in einem anderen Finish der Möbel separat hinzufügen. / Для верхнего внутреннего фасада в другой отделке мебели добавить отдельно.



| Cod.  | L   | Corian®      | MN    | UHS | LM/LT/LB | S1/S3/S4 | MDi |
|-------|-----|--------------|-------|-----|----------|----------|-----|
|       |     | Solidsurface | MC/MP |     |          |          |     |
| BP108 | 80  |              |       |     |          |          |     |
| BP110 | 100 |              |       |     |          |          |     |
| BP112 | 120 |              |       |     |          |          |     |
| BP114 | 140 |              |       |     |          |          |     |
| BP116 | 160 |              |       |     |          |          |     |
| BP118 | 180 |              |       |     |          |          |     |
| BP120 | 200 |              |       |     |          |          |     |
| BP122 | 220 |              |       |     |          |          |     |



ES Módulo compacto suspendido o al suelo con tres cajones.

IT Modulo compatto sospeso o al pavimento con tre cassetti.

EN Wall mounted or floor standing unit with three drawers.

GE Kompaktes Hänge- oder Bodenmodul mit zwei Schubladen.

FR Meuble à suspendre ou au sol avec trois tiroirs.

RU Подвесной или напольный компактный модуль с тремя ящиками.

 REVERSIBLE

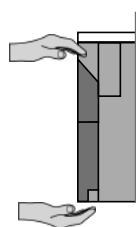
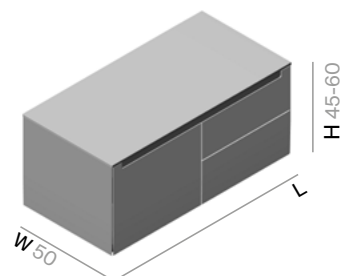

| Cod.   | H  | L   | LM/LT | LB | S3/S4 | MDi |
|--------|----|-----|-------|----|-------|-----|
| ST501  | 45 | 80  |       |    |       |     |
| ST509  | 45 | 100 |       |    |       |     |
| ST508  | 45 | 120 |       |    |       |     |
| ST742  | 45 | 140 |       |    |       |     |
| ST743  | 45 | 160 |       |    |       |     |
| ST757  | 45 | 180 |       |    |       |     |
| ST1053 | 45 | 200 |       |    |       |     |
| ST1054 | 45 | 220 |       |    |       |     |
| ST793  | 60 | 80  |       |    |       |     |
| ST795  | 60 | 100 |       |    |       |     |
| ST796  | 60 | 120 |       |    |       |     |
| ST797  | 60 | 140 |       |    |       |     |
| ST798  | 60 | 160 |       |    |       |     |
| ST799  | 60 | 180 |       |    |       |     |
| ST1071 | 60 | 200 |       |    |       |     |
| ST1072 | 60 | 220 |       |    |       |     |



Para barramento en distinto acabado del mueble añadir aparte. / For upper inner front in a different finish of the furniture add separately. / Partie frontale en différente finition, à rajouter. / Struttura frontale interno superiore in una diversa finitura del mobile aggiungere a parte. / Für Frontschürze innen sichtbar in einem anderen Finish der Möbel separat hinzufügen. / Для верхнего внутреннего фасада в другой отделке мебели добавить отдельно.

| Cod.  | L   | Corian®<br>Solidsurface | MN<br>MC/MP | UHS | LM/LT/LB | S1/S3/S4 | MDi |
|-------|-----|-------------------------|-------------|-----|----------|----------|-----|
| BP108 | 80  |                         |             |     |          |          |     |
| BP110 | 100 |                         |             |     |          |          |     |
| BP112 | 120 |                         |             |     |          |          |     |
| BP114 | 140 |                         |             |     |          |          |     |
| BP116 | 160 |                         |             |     |          |          |     |
| BP118 | 180 |                         |             |     |          |          |     |
| BP120 | 200 |                         |             |     |          |          |     |
| BP122 | 220 |                         |             |     |          |          |     |

LM Laca Mate / Matt Lacquer / Laqué Mat / Laccato Opaco / Mattlack / Матовый лак  
 LT Laca Texturizada / Textured Lacquer / Laqué Texturé / Laccato Testurizzato / Strukturlack / Текстурированный лак  
 LB Laca Brillo / Glossy Lacquer / Laqué Brillant / Lacca Lucida / Glanzlack / Глянцевая медь  
 S1 Madera natural / Natural wood / Bois Naturel / Legno Naturale / Echtholz / Натуральное дерево  
 S3 Roble salvaje / Wild oak / Chêne sauvage / Rovere selvaggio / Natureiche / Дикая дуб

S4 Roble Raw / Raw oak / Chêne Raw / Rovere Raw / Roheiche / Raw дуб  
 MN Mármol Marquina / Marquina Marble / Marbre Marquina / Marmo di Marquina / Marquina-Marmor / Мрамор  
 MC Mármol Carrara / Carrara Marble / Marbre Carrara / Marmo di Carrara / Carrara-Marmor / Каррарский мрамор  
 MP Mármol Pietra Grey / Pietra Grey Marble / Marbre Pietra Grey / Marmo Pietra Grey / Pietra Grey Marmor / Мрамор

ES Módulo compacto suspendido o al suelo con cuatro cajones.

IT Modulo compatto sospeso o al pavimento con quattro cassetti.

EN Wall mounted or floor standing unit with four drawers.

GE Kompaktes Hänge- oder Bodenmodul mit vier Schubladen.

FR Meuble à suspendre ou au sol avec quatre tiroirs.

RU Подвесной или напольный компактный модуль с четырьмя ящиками.

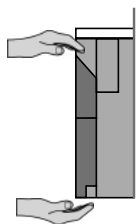
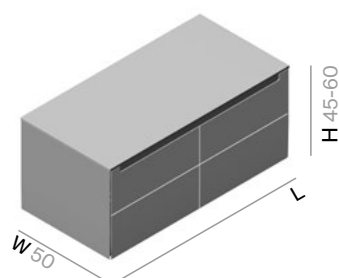

| Cod.   | H  | L   | LM/LT | LB | S3/S4 | MDi |
|--------|----|-----|-------|----|-------|-----|
| ST748  | 45 | 80  |       |    |       |     |
| ST751  | 45 | 100 |       |    |       |     |
| ST752  | 45 | 120 |       |    |       |     |
| ST754  | 45 | 140 |       |    |       |     |
| ST755  | 45 | 160 |       |    |       |     |
| ST758  | 45 | 180 |       |    |       |     |
| ST1055 | 45 | 200 |       |    |       |     |
| ST1056 | 45 | 220 |       |    |       |     |
| ST736  | 60 | 80  |       |    |       |     |
| ST738  | 60 | 100 |       |    |       |     |
| ST739  | 60 | 120 |       |    |       |     |
| ST740  | 60 | 140 |       |    |       |     |
| ST741  | 60 | 160 |       |    |       |     |
| ST764  | 60 | 180 |       |    |       |     |
| ST1073 | 60 | 200 |       |    |       |     |
| ST1074 | 60 | 220 |       |    |       |     |

Para barramento en distinto acabado del mueble añadir aparte. / For upper inner front in a different finish of the furniture add separately. / Partie frontale en différente finition, à rajouter. / Struttura frontale interno superiore in una diversa finitura del mobile aggiungere a parte. / Für Frontschürze innen sichtbar in einem anderen Finish der Möbel separat hinzufügen. / Для верхнего внутреннего фасада в другой отделке мебели добавить отдельно.

| Cod.  | L   | Corian®      | MN    | UHS | LM/LT/LB | S1/S3/S4 | MDi |
|-------|-----|--------------|-------|-----|----------|----------|-----|
|       |     | Solidsurface | MC/MP |     |          |          |     |
| BP108 | 80  |              |       |     |          |          |     |
| BP110 | 100 |              |       |     |          |          |     |
| BP112 | 120 |              |       |     |          |          |     |
| BP114 | 140 |              |       |     |          |          |     |
| BP116 | 160 |              |       |     |          |          |     |
| BP118 | 180 |              |       |     |          |          |     |
| BP120 | 200 |              |       |     |          |          |     |
| BP122 | 220 |              |       |     |          |          |     |

LM Laca Mate / Matt Lacquer / Laqué Mat / Laccato Opaco / Mattlack / Матовый лак  
 LT Laca Texturizada / Textured Lacquer / Laqué Texturé / Laccato Testurizzato / Strukturlack / Текстурированный лак  
 LB Laca Brillo / Glossy Lacquer / Laqué Brillant / Lacca Lucida / Glanzlack / Глянцевая медь  
 S1 Madera natural / Natural wood / Bois Naturel / Legno Naturale / Echtholz / Натуральное дерево  
 S3 Roble salvaje / Wild oak / Chêne sauvage / Rovere selvaggio / Natureiche / Дикая дуб

S4 Roble Raw / Raw oak / Chêne Raw / Rovere Raw / Roheiche / Raw дуб  
 MN Marmor Marquina / Marquina Marble / Marbre Marquina / Marmo di Marquina / Marquina-Marmor / Мрамор  
 MC Marmor Carrara / Carrara Marble / Marbre Carrara / Marmo di Carrara / Carrara-Marmor / Каррарский мрамор  
 MP Marmor Pietra Grey / Pietra Grey Marble / Marbre Pietra Grey / Marmo Pietra Grey / Pietra Grey Marmor / Мрамор

ES Módulo compacto suspendido o al suelo con tres cajones.

IT Modulo compatto sospeso o al pavimento con tre cassetti.

EN Wall mounted or floor standing unit with three drawers.

GE Kompaktes Hänge- oder Bodenmodul mit drei Schubladen.

FR Meuble à suspendre ou au sol avec trois tiroirs.

RU Подвесной или напольный компактный модуль с тремя ящиками.

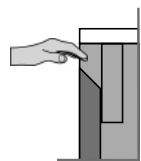
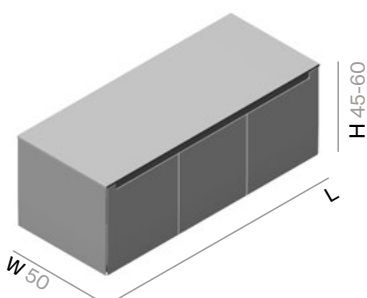

| Cod.   | H  | L   | LM/LT | LB | S3/S4 | MDi |
|--------|----|-----|-------|----|-------|-----|
| ST774  | 45 | 120 |       |    |       |     |
| ST775  | 45 | 140 |       |    |       |     |
| ST776  | 45 | 160 |       |    |       |     |
| ST777  | 45 | 180 |       |    |       |     |
| ST1057 | 45 | 200 |       |    |       |     |
| ST1058 | 45 | 220 |       |    |       |     |
| ST812  | 60 | 120 |       |    |       |     |
| ST813  | 60 | 140 |       |    |       |     |
| ST814  | 60 | 160 |       |    |       |     |
| ST815  | 60 | 180 |       |    |       |     |
| ST1075 | 60 | 200 |       |    |       |     |
| ST1076 | 60 | 220 |       |    |       |     |



Para barramento en distinto acabado del mueble añadir aparte. / For upper inner front in a different finish of the furniture add separately. / Partie frontale en différente finition, à rajouter. / Struttura frontale interno superiore in una diversa finitura del mobile aggiungere a parte. / Für Frontschürze innen sichtbar in einem anderen Finish der Möbel separat hinzufügen. / Для верхнего внутреннего фасада в другой отделке мебели добавить отдельно.

| Cod.  | L   | Corian®<br>Solidsurface | MN<br>MC/MP | UHS | LM/LT/LB | S1/S3/S4 | MDi |
|-------|-----|-------------------------|-------------|-----|----------|----------|-----|
| BP112 | 120 |                         |             |     |          |          |     |
| BP114 | 140 |                         |             |     |          |          |     |
| BP116 | 160 |                         |             |     |          |          |     |
| BP118 | 180 |                         |             |     |          |          |     |
| BP120 | 200 |                         |             |     |          |          |     |
| BP122 | 220 |                         |             |     |          |          |     |

LM Laca Mate / Matt Lacquer / Laqué Mat / Laccato Opaco / Mattlack / Матовый лак  
 LT Laca Texturizada / Textured Lacquer / Laqué Texturé / Laccato Testurizzato / Strukturlack / Текстурированный лак  
 LB Laca Brillo / Glossy Lacquer / Laqué Brillant / Lacca Lucida / Glanzlack / Глянцевая медь  
 S1 Madera natural / Natural wood / Bois Naturel / Legno Naturale / Echtholz / Натуральное дерево  
 S3 Roble salvaje / Wild oak / Chêne sauvage / Rovere selvaggio / Natureiche / Дикая дуб

S4 Roble Raw / Raw oak / Chêne Raw / Rovere Raw / Roheiche / Raw дуб  
 MN Marmor Marquina / Marquina Marble / Marbre Marquina / Marmo di Marquina / Marquina-Marmor / Мрамор  
 MC Marmor Carrara / Carrara Marble / Marbre Carrara / Marmo di Carrara / Carrara-Marmor / Каррарский мрамор  
 MP Marmor Pietra Grey / Pietra Grey Marble / Marbre Pietra Grey / Marmo Pietra Grey / Pietra Grey Marmor / Мрамор

ES Módulo compacto suspendido o al suelo con cuatro cajones.

IT Modulo compatto sospeso o al pavimento con quattro cassetti.

EN Wall mounted or floor standing unit with four drawers.

GE Kompaktes Hänge- oder Bodenmodul mit vier Schubladen.

FR Meuble à suspendre ou au sol avec quatre tiroirs.

RU Подвесной или напольный компактный модуль с четырьмя ящиками.

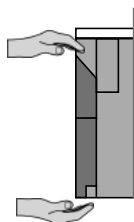
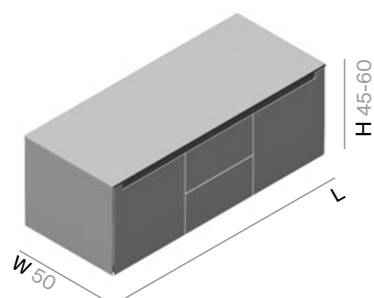

| Cod.   | H  | L   | LM/LT | LB | S3/S4 | MDi |
|--------|----|-----|-------|----|-------|-----|
| ST778  | 45 | 120 |       |    |       |     |
| ST779  | 45 | 140 |       |    |       |     |
| ST780  | 45 | 160 |       |    |       |     |
| ST781  | 45 | 180 |       |    |       |     |
| ST1059 | 45 | 200 |       |    |       |     |
| ST1060 | 45 | 220 |       |    |       |     |
| ST819  | 60 | 120 |       |    |       |     |
| ST823  | 60 | 140 |       |    |       |     |
| ST827  | 60 | 160 |       |    |       |     |
| ST845  | 60 | 180 |       |    |       |     |
| ST1077 | 60 | 200 |       |    |       |     |
| ST1078 | 60 | 220 |       |    |       |     |



Para barramento en distinto acabado del mueble añadir aparte. / For upper inner front in a different finish of the furniture add separately. / Partie frontale en différente finition, à rajouter. / Struttura frontale interno superiore in una diversa finitura del mobile aggiungere a parte. / Für Frontschürze innen sichtbar in einem anderen Finish der Möbel separat hinzufügen. / Для верхнего внутреннего фасада в другой отделке мебели добавить отдельно.

| Cod.  | L   | Corian®      | MN    | UHS | LM/LT/LB | S1/S3/S4 | MDi |
|-------|-----|--------------|-------|-----|----------|----------|-----|
|       |     | Solidsurface | MC/MP |     |          |          |     |
| BP112 | 120 |              |       |     |          |          |     |
| BP114 | 140 |              |       |     |          |          |     |
| BP116 | 160 |              |       |     |          |          |     |
| BP118 | 180 |              |       |     |          |          |     |
| BP120 | 200 |              |       |     |          |          |     |
| BP122 | 220 |              |       |     |          |          |     |

LM Laca Mate / Matt Lacquer / Laqué Mat / Laccato Opaco / Mattlack / Матовый лак  
 LT Laca Texturizada / Textured Lacquer / Laqué Texturé / Laccato Testurizzato / Strukturlack / Текстурированный лак  
 LB Laca Brillo / Glossy Lacquer / Laqué Brillant / Lacca Lucida / Glanzlack / Глянцевая медь  
 S1 Madera natural / Natural wood / Bois Naturel / Legno Naturale / Echtholz / Натуральное дерево  
 S3 Roble salvaje / Wild oak / Chêne sauvage / Rovere selvaggio / Natureiche / Дикая дуб

S4 Roble Raw / Raw oak / Chêne Raw / Rovere Raw / Roheiche / Raw дуб  
 MN Mármol Marquina / Marquina Marble / Marbre Marquina / Marmo di Marquina / Marquina-Marmor / Мрамор  
 MC Mármol Carrara / Carrara Marble / Marbre Carrara / Marmo di Carrara / Carrara-Marmor / Каррарский мрамор  
 MP Mármol Pietra Grey / Pietra Grey Marble / Marbre Pietra Grey / Marmo Pietra Grey / Pietra Grey Marmor / Мрамор

ES Módulo compacto suspendido o al suelo con cuatro cajones.

IT Modulo compatto sospeso o al pavimento con quattro cassetti.

EN Wall mounted or floor standing unit with four drawers.

GE Kompaktes Hänge- oder Bodenmodul mit vier Schubladen.

FR Meuble à suspendre ou au sol avec quatre tiroirs.

RU Подвесной или напольный компактный модуль с четырьмя ящиками.

 REVERSIBLE

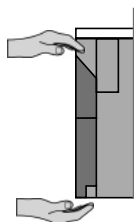
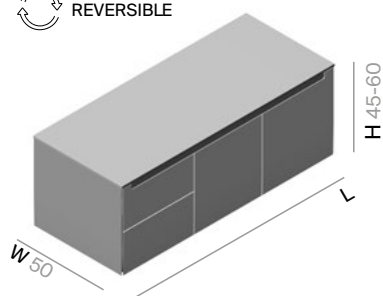

| Cod.   | H  | L   | LM/LT | LB | S3/S4 | MDi |
|--------|----|-----|-------|----|-------|-----|
| ST969  | 45 | 120 |       |    |       |     |
| ST970  | 45 | 140 |       |    |       |     |
| ST971  | 45 | 160 |       |    |       |     |
| ST972  | 45 | 180 |       |    |       |     |
| ST1061 | 45 | 200 |       |    |       |     |
| ST1062 | 45 | 220 |       |    |       |     |
| ST1200 | 60 | 120 |       |    |       |     |
| ST1201 | 60 | 140 |       |    |       |     |
| ST1202 | 60 | 160 |       |    |       |     |
| ST1203 | 60 | 180 |       |    |       |     |
| ST1204 | 60 | 200 |       |    |       |     |
| ST1205 | 60 | 220 |       |    |       |     |



Para barramento en distinto acabado del mueble añadir aparte. / For upper inner front in a different finish of the furniture add separately. / Partie frontale en différente finition, à rajouter. / Struttura frontale interno superiore in una diversa finitura del mobile aggiungere a parte. / Für Frontschürze innen sichtbar in einem anderen Finish der Möbel separat hinzufügen. / Для верхнего внутреннего фасада в другой отделке мебели добавить отдельно.

| Cod.  | L   | Corian®<br>Solidsurface | MN<br>MC/MP | UHS | LM/LT/LB | S1/S3/S4 | MDi |
|-------|-----|-------------------------|-------------|-----|----------|----------|-----|
| BP112 | 120 |                         |             |     |          |          |     |
| BP114 | 140 |                         |             |     |          |          |     |
| BP116 | 160 |                         |             |     |          |          |     |
| BP118 | 180 |                         |             |     |          |          |     |
| BP120 | 200 |                         |             |     |          |          |     |
| BP122 | 220 |                         |             |     |          |          |     |

LM Laca Mate / Matt Lacquer / Laqué Mat / Laccato Opaco / Mattlack / Матовый лак  
 LT Laca Texturizada / Textured Lacquer / Laqué Texturé / Laccato Testurizzato / Strukturlack / Текстурированный лак  
 LB Laca Brillo / Glossy Lacquer / Laqué Brillant / Lacca Lucida / Glanzlack / Глянцевая медь  
 S1 Madera natural / Natural wood / Bois Naturel / Legno Naturale / Echtholz / Натуральное дерево  
 S3 Roble salvaje / Wild oak / Chêne sauvage / Rovere selvaggio / Natureiche / Дикая дуб

S4 Roble Raw / Raw oak / Chêne Raw / Rovere Raw / Roheiche / Raw дуб  
 MN Marmor Marquina / Marquina Marble / Marbre Marquina / Marmo di Marquina / Marquina-Marmor / Мрамор  
 MC Marmor Carrara / Carrara Marble / Marbre Carrara / Marmo di Carrara / Carrara-Marmor / Каррарский мрамор  
 MP Marmor Pietra Grey / Pietra Grey Marble / Marbre Pietra Grey / Marmo Pietra Grey / Pietra Grey Marmor / Мрамор

ES Módulo compacto suspendido o al suelo con cinco cajones.

IT Modulo compatto sospeso o al pavimento con cinque cassetti.

EN Wall mounted or floor standing unit with five drawers.

GE Kompaktes Hänge- oder Bodenmodul mit fünf Schubladen.

FR Meuble à suspendre ou au sol avec cinq tiroirs.

RU Подвесной или напольный компактный модуль с тремя ящиками.

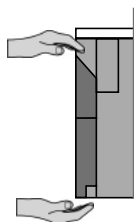
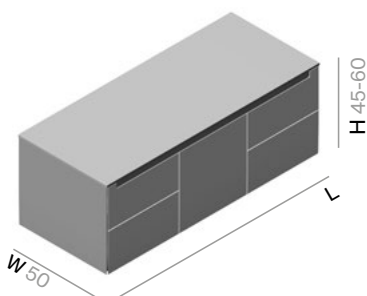

| Cod.   | H  | L   | LM/LT | LB | S3/S4 | MDi |
|--------|----|-----|-------|----|-------|-----|
| ST977  | 45 | 120 |       |    |       |     |
| ST978  | 45 | 140 |       |    |       |     |
| ST979  | 45 | 160 |       |    |       |     |
| ST980  | 45 | 180 |       |    |       |     |
| ST1065 | 45 | 200 |       |    |       |     |
| ST1066 | 45 | 220 |       |    |       |     |
| ST1212 | 60 | 120 |       |    |       |     |
| ST1213 | 60 | 140 |       |    |       |     |
| ST1214 | 60 | 160 |       |    |       |     |
| ST1215 | 60 | 180 |       |    |       |     |
| ST1216 | 60 | 200 |       |    |       |     |
| ST1217 | 60 | 220 |       |    |       |     |



Para barramento en distinto acabado del mueble añadir aparte. / For upper inner front in a different finish of the furniture add separately. / Partie frontale en différente finition, à rajouter. / Struttura frontale interno superiore in una diversa finitura del mobile aggiungere a parte. / Für Frontschürze innen sichtbar in einem anderen Finish der Möbel separat hinzufügen. / Для верхнего внутреннего фасада в другой отделке мебели добавить отдельно.

| Cod.  | L   | Corian®<br>Solidsurface | MN<br>MC/MP | UHS | LM/LT/LB | S1/S3/S4 | MDi |
|-------|-----|-------------------------|-------------|-----|----------|----------|-----|
| BP112 | 120 |                         |             |     |          |          |     |
| BP114 | 140 |                         |             |     |          |          |     |
| BP116 | 160 |                         |             |     |          |          |     |
| BP118 | 180 |                         |             |     |          |          |     |
| BP120 | 200 |                         |             |     |          |          |     |
| BP122 | 220 |                         |             |     |          |          |     |

LM Laca Mate / Matt Lacquer / Laqué Mat / Laccato Opaco / Mattlack / Матовый лак

S4 Roble Raw / Raw oak / Chêne Raw / Rovere Raw / Roheiche / Raw дуб

LT Laca Texturizada / Textured Lacquer / Laqué Texturé / Laccato Testurizzato / Strukturlack / Текстурированный лак

MN Marmor Marquina / Marquina Marble / Marbre Marquina / Marmo di Marquina / Marquina-Marmor / Мрамор

LB Laca Brillo / Glossy Lacquer / Laqué Brillant / Lacca Lucida / Glanzlack / Глянцевая медь

MC Marmor Carrara / Carrara Marble / Marbre Carrara / Marmo di Carrara / Carrara-Marmor / Каррарский мрамор

S1 Madera natural / Natural wood / Bois Naturel / Legno Naturale / Echtholz / Натуральное дерево

MP Marmor Pietra Grey / Pietra Grey Marble / Marbre Pietra Grey / Marmo Pietra Grey / Pietra Grey Marmor / Мрамор

S3 Roble salvaje / Wild oak / Chêne sauvage / Rovere selvaggio / Natureiche / Дикая дуб

|    |   |    |   |
|----|---|----|---|
| ES | Módulo suspendido o al suelo con puerta. Dirección apertura de la puerta a elegir. Equipado con estante interior.           | IT | Modulo sospeso o al pavimento con porta. Direzione di apertura dell'anta a scelta. Dotato di ripiano interno. |
| EN | Wall mounted or floor standing unit with door. You can mount the door to open from the right or left. Inner shelf included. | GE | Hänge- oder Bodenmodul mit Tür. Anschlag/Öffnung der Tür nach Wahl. Ausgestattet mit Innenablage.             |
| FR | Meuble à suspendre ou au sol avec une porte. Sens d'ouverture de la porte à choisir. Avec étagère intérieure.               | RU | Подвесной или напольный модуль с дверцей. Направление открытия дверцы на выбор. Внутренняя полка.             |

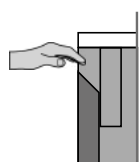
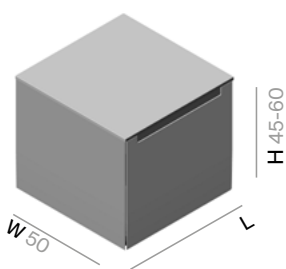

| Cod.  | H  | L  | LM/LT | LB | S3/S4 | MDi |
|-------|----|----|-------|----|-------|-----|
| ST323 | 45 | 30 |       |    |       |     |
| ST311 | 45 | 40 |       |    |       |     |
| ST981 | 45 | 60 |       |    |       |     |
| ST324 | 60 | 30 |       |    |       |     |
| ST313 | 60 | 40 |       |    |       |     |
| ST995 | 60 | 60 |       |    |       |     |



Para barramento en distinto acabado del mueble añadir aparte. / For upper inner front in a different finish of the furniture add separately. / Partie frontale en différente finition, à rajouter. / Struttura frontale interno superiore in una diversa finitura del mobile aggiungere a parte. / Für Frontschürze innen sichtbar in einem anderen Finish der Möbel separat hinzufügen. / Для верхнего внутреннего фасада в другой отделке мебели добавить отдельно.

| Cod.  | L  | Corian®<br>Solidsurface | MN<br>MC/MP | UHS | LM/LT/LB | S1/S3/S4 | MDi |
|-------|----|-------------------------|-------------|-----|----------|----------|-----|
| BP104 | 40 |                         |             |     |          |          |     |
| BP106 | 60 |                         |             |     |          |          |     |

|    |  |    |  |
|----|--|----|--|
| LM | Laca Mate / Matt Lacquer / Laqué Mat / Laccato Opaco / Mattlack / Матовый лак                                    | S4 | Roble Raw / Raw oak / Chêne Raw / Rovere Raw / Roheiche / Raw дуб  |
| LT | Laca Texturizada / Textured Lacquer / Laqué Texturé / Laccato Testurizzato / Strukturlack / Текстурированный лак | MN | Mármol Marquina / Marquina Marble / Marbre Marquina / Marmo di Marquina / Marquina-Marmor / Мрамор             |
| LB | Laca Brillo / Glossy Lacquer / Laqué Brillant / Lacca Lucida / Glanzlack / Глянцевая медь                        | MC | Mármol Carrara / Carrara Marble / Marbre Carrara / Marmo di Carrara / Carrara-Marmor / Каррарский мрамор       |
| S1 | Madera natural / Natural wood / Bois Naturel / Legno Naturale / Echtholz / Натуральное дерево                    | MP | Mármol Pietra Grey / Pietra Grey Marble / Marbre Pietra Grey / Marmo Pietra Grey / Pietra Grey Marmor / Мрамор |
| S3 | Roble salvaje / Wild oak / Chêne sauvage / Rovere selvaggio / Natureiche / Дикая дуб                             |    |  |

ES Módulo suspendido o al suelo con dos puertas. Equipado con estante interior.

IT Modulo sospeso o al pavimento con due porte. Dotato di ripiano interno.

EN Wall mounted or floor standing unit with two doors. Inner shelf included.

GE Hänge- oder Bodenmodul mit zwei Türen. Ausgestattet mit Innenablage.

FR Meuble à suspendre ou au sol avec deux portes. Avec étagère intérieure.

RU Подвесной или напольный модуль с двумя дверцами. Внутренняя полка.

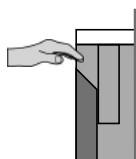
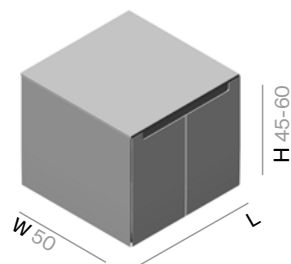

| Cod.  | H  | L   | LM/LT | LB | S3/S4 | MDi |
|-------|----|-----|-------|----|-------|-----|
| ST314 | 45 | 60  |       |    |       |     |
| ST321 | 45 | 80  |       |    |       |     |
| ST704 | 45 | 100 |       |    |       |     |
| ST982 | 45 | 120 |       |    |       |     |
| ST317 | 60 | 60  |       |    |       |     |
| ST320 | 60 | 80  |       |    |       |     |
| ST713 | 60 | 100 |       |    |       |     |
| ST996 | 60 | 120 |       |    |       |     |



Para barramento en distinto acabado del mueble añadir aparte. / For upper inner front in a different finish of the furniture add separately. / Partie frontale en différente finition, à rajouter. / Struttura frontale interno superiore in una diversa finitura del mobile aggiungere a parte. / Für Frontschürze innen sichtbar in einem anderen Finish der Möbel separat hinzufügen. / Для верхнего внутреннего фасада в другой отделке мебели добавить отдельно.

| Cod.  | L   | Corian®      | MN    | UHS | LM/LT/LB | S1/S3/S4 | MDi |
|-------|-----|--------------|-------|-----|----------|----------|-----|
|       |     | Solidsurface | MC/MP |     |          |          |     |
| BP106 | 60  |              |       |     |          |          |     |
| BP108 | 80  |              |       |     |          |          |     |
| BP110 | 100 |              |       |     |          |          |     |
| BP112 | 120 |              |       |     |          |          |     |

LM Laca Mate / Matt Lacquer / Laqué Mat / Laccato Opaco / Mattlack / Матовый лак  
 LT Laca Texturizada / Textured Lacquer / Laqué Texturé / Laccato Testurizzato / Strukturlack / Текстурированный лак  
 LB Laca Brillo / Glossy Lacquer / Laqué Brillant / Lacca Lucida / Glanzlack / Глянцевая медь  
 S1 Madera natural / Natural wood / Bois Naturel / Legno Naturale / Echtholz / Натуральное дерево  
 S3 Roble salvaje / Wild oak / Chêne sauvage / Rovere selvaggio / Natureiche / Дикая дуб

S4 Roble Raw / Raw oak / Chêne Raw / Rovere Raw / Roheiche / Raw дуб  
 MN Mármol Marquina / Marquina Marble / Marbre Marquina / Marmo di Marquina / Marquina-Marmor / Мрамор  
 MC Mármol Carrara / Carrara Marble / Marbre Carrara / Marmo di Carrara / Carrara-Marmor / Каррарский мрамор  
 MP Mármol Pietra Grey / Pietra Grey Marble / Marbre Pietra Grey / Marmo Pietra Grey / Pietra Grey Marmor / Мрамор