

I SISTEMA / SYSTEM



CI
 Costado Ingletado
 Mitred sides
 Côté coupe en onglet
 Fiancone con angolo
 Seitenelement mit gehrung
 Боковая сторона, соединенная под углом

U3A
 Apertura superior en inglete
 Top opening system
 Poignée cuvette supérieure
 Apertura superiore
 Daumenloch oben
 Ручка фрезерованная верхняя со срезом



1 Cajón / 1 Drawer

U3A

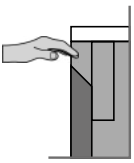

1 Cajón / 1 Drawer

U3C

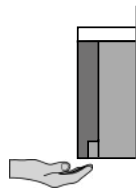

2 Cajones / 2 Drawers

U3A

U3C

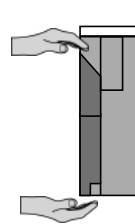

2 Cajones / 2 Drawers

U3B

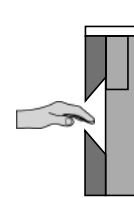

ACABADOS / FINISHES / FINITIONS / FINITURE / OBERFLÄCHENAUSFÜHRUNG / ОТДЕЛК

ES Por defecto los módulos vienen con tapa simple y barramento en el acabado escogido, si se desea cambiar el acabado de la tapa y/o barramento será necesario añadir estos elementos aparte en el acabado deseado.

EN By default, the modules come with a simple top and bar in the chosen finish. If you want to change the finish of the top and / or bar, the desired finish can be added separately.

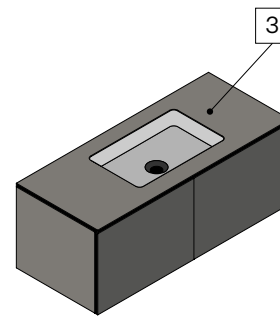
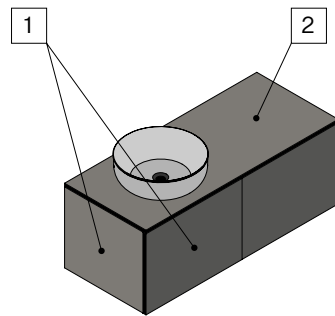

- 1
 LM - Laca Mate / Matt Lacquer
 LT - Laca Texturizada / Textured Lacquer
 LB - Laca Brillo / Glossy Lacquer
 S1 - Madera Natural / Natural wood
 S3 - Roble salvaje / Wild oak
 S4 - Roble Raw / Raw oak

- 2
 Corian
 Solidsurface
 Mármol / Marble (MP, MC, MN)
 UHS Color / UHS Colour
 LM - Laca Mate / Matt Lacquer
 LT - Laca Texturizada / Textured Lacquer
 LB - Laca Brillo / Glossy Lacquer
 S3 - Roble salvaje / Wild oak
 S4 - Roble Raw / Raw oak
 CB - Cristal Brillo / Glossy glass
 CM - Cristal Mate/ Matt glass
 MDi

- 3
 Corian
 Solidsurface
 UHS Color / UHS Colour
 Mármol / Marble (MP, MC, MN)
 MDi

- ES** Por defecto los pedidos de referencias independientes se fabrican como en su respectiva imagen representativa, cerrados con tapa simple, íntegramente en el acabado escogido. Si desea que el módulo quede abierto por arriba debe indicarlo. Para cambiar el acabado de la tapa o barramento/s deberá añadir esta referencia aparte. Para añadir tapa con lavabo/s integrado/s deberá añadir esta referencia aparte. Para realizar modulaciones entre distintas referencias deberá añadir al pedido las distintas referencias de la modulación así como una tapa de cierre simple o con lavabo/s en el acabado deseado y de la medida L total correspondiente al total de la modulación. Cuando se realizan modulaciones entre distintas referencias la construcción de los módulos será modificada en los puntos de unión de manera que el aspecto final de la composición sea el determinado por el sistema. Las composiciones de módulos inferiores a L180 cm podrán ser convertidas a módulos compactos y se enviarán montadas en una sola pieza. Para módulos abiertos ubicados en los extremos de la composición, opcionalmente puede añadir lateral/es decorativo/s para el cierre de la misma.
- EN** By default, orders for independent items are manufactured as seen in the photo using a simple cover, entirely in the chosen finish. If you want the module to be open at the top, please let us know. To change the finish of the top or bar / s, please add the item. A lid with an integrated basin / s has to be added separately. To make modules from different references, each one must be added to the order, such as a single closing lid or a washbasin / s in the desired finish, and the total L measurement will correspond to the entire module. When modules are made up using different references, the construction of the modules is modified at the joints so that the final appearance of the composition is determined by the system. The compositions of modules smaller than L180 cm can be converted to compact modules and will be shipped ready-assembled in a single piece. For modules located at the ends of the composition, decorative side(s) must be included to finish it off.
- FR** Par défaut, les commandes de références indépendantes sont fabriquées comme sur leur image représentative respective, fermées par un simple plateau, entièrement dans la finition choisie. Si vous souhaitez que le module soit ouvert sur le dessus, vous devez le préciser. Pour changer la finition du plateau ou de la/des barre/s, vous devrez ajouter cette référence à part. Pour ajouter un plateau avec vasque/s intégrée(s), vous devrez ajouter cette référence à part. Pour effectuer des modulations entre différentes références, les différentes références de la modulation devront être ajoutées à la commande, ainsi qu'un plateau simple ou avec lavabo/s dans la finition souhaitée et de taille L totale correspondant à la modulation totale. Lorsque des modulations sont faites entre différentes références, la construction des modules sera modifiée aux points de jonction pour que l'aspect final de la composition soit déterminé par le système. Les compositions de modules inférieurs à L180 cm pourront être converties en modules compacts et seront expédiées assemblées en une seule pièce. Pour les modules ouverts situés aux extrémités de la composition, vous devez ajouter un/des côté(s) décoratif(s) pour le fermer.
- IT** Per default, gli ordini di articoli indipendenti sono fabbricati come si vede nella foto con una semplice copertura, interamente nella finitura scelta. Se vuoi che il modulo sia aperto nella parte superiore, ti preghiamo di farcelo sapere. Per cambiare la finitura del piano o della barra / s, si prega di aggiungere l'articolo. Un coperchio con una vasca integrata / s deve essere aggiunto separatamente. Per comporre i moduli a partire da diverse referenze, occorre aggiungere all'ordine ognuna di esse, come un singolo coperchio di chiusura o un lavabo / s nella finitura desiderata, e la misura totale L corrisponderà all'intero modulo. Quando i moduli vengono composti con riferimenti diversi, la costruzione dei moduli viene modificata nelle giunzioni in modo che l'aspetto finale della composizione sia determinato dal sistema. Le composizioni di moduli più piccoli di L180 cm possono essere convertite in moduli compatti e saranno spedite già assemblate in un unico pezzo. Per i moduli situati alle estremità della composizione, è necessario includere uno o più lati decorativi per rifinirla.
- GE** Standardmäßig werden Bestellungen für eigenständige Artikel wie auf dem Foto zu sehen mit einem einfachen Deckel, ganz in der gewählten Ausführung, gefertigt. Wenn Sie das Modul an der Spitze offen sein soll, lassen Sie es uns bitte wissen. Um die Ausführung des Deckels oder der Bar / s zu ändern, fügen Sie bitte den Artikel hinzu. Ein Deckel mit einem integrierten Becken / s muss separat hinzugefügt werden. Um Module aus verschiedenen Referenzen zu machen, muss jeder der Bestellung hinzugefügt werden, wie z. B. eine einzelne Schließdeckel oder ein Waschbecken / s in der gewünschten Ausführung, und die gesamte L-Messung wird auf das gesamte Modul entsprechen. Bei der Zusammenstellung von Modulen mit verschiedenen Referenzen wird die Konstruktion der Module an den Verbindungsstellen geändert, so dass das endgültige Aussehen der Zusammensetzung durch das System bestimmt wird. Die Zusammenstellungen von Modulen, die kleiner als L180cm sind, können in Kompaktmodule umgewandelt werden und werden in einem Stück fertig montiert geliefert. Für Module, die sich an den Enden der Komposition befinden, müssen dekorative Seiten hinzugefügt werden, um die Komposition abzuschließen.
- RU** По умолчанию заказы на независимые изделия изготавливаются, как показано на фотографии, с использованием простой крышки, полностью в выбранной отделке. Если вы хотите, чтобы модуль был открыт сверху, пожалуйста, сообщите нам об этом. Чтобы изменить отделку верха или планки / с, пожалуйста, добавьте этот элемент. Крышка со встроенной раковиной / с должна быть добавлена отдельно. Для составления модулей из разных артикулов, каждый из них должен быть добавлен к заказу, например, одна закрывающаяся крышка или умывальник / с в желаемой отделке, и общее измерение L будет соответствовать всему модулю. При составлении модулей с использованием различных эталонов конструкция модулей изменяется на стыках, так что окончательный вид композиции определяется системой. Композиции из модулей размером менее L180 см могут быть преобразованы в компактные модули и будут поставляться в собранном виде. Для модулей, расположенных на концах композиции, необходимо включить декоративную сторону (стороны), чтобы завершить ее.

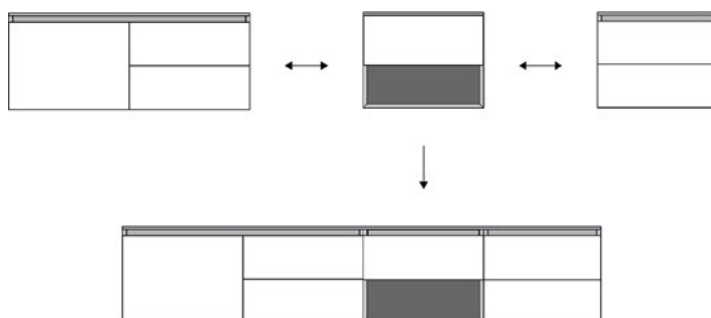

CONFIGURACIONES / CONFIGURATIONS

Módulos individuales / Individual units



H30 cm · L30-140 cm



H45 cm · L30-110 cm
H60 cm · L30-110 cm
H90 cm · L30-80 cm



H45 cm · L45-110 cm
H60 cm · L45-110 cm



H30 cm · L30-120 cm

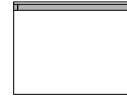

H45 cm · L30-120 cm
H60 cm · L40-100 cm

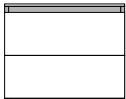

H45 cm · L30-120 cm



H60 cm · L40-120 cm

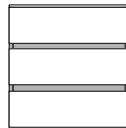

H60 cm · L40-120 cm
H90 cm · L40-120 cm

Módulos con puerta / Door units

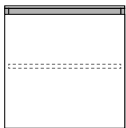

H45 cm · L30-60 cm
H60 cm · L30-60 cm
H90 cm · L30-60 cm

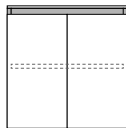

H45 cm · L60-120 cm
H60 cm · L60-120 cm
H90 cm · L60-120 cm

CONFIGURACIONES / CONFIGURATIONS

Módulos compactos / Compact units



H30 cm · L80-220 cm

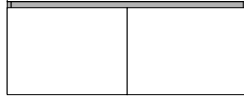

H45 cm · L80-220 cm
H60 cm · L80-220 cm

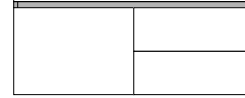

H45 cm · L80-220 cm
H60 cm · L80-220 cm

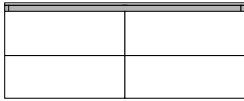

H45 cm · L80-220 cm



H60 cm · L80-220 cm
H90 cm · L80-180 cm

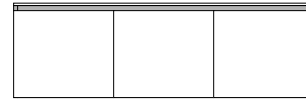

H45 cm · L120-220 cm
H60 cm · L120-220 cm

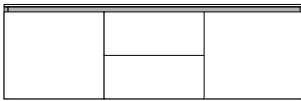

H45 cm · L120-220 cm
H60 cm · L120-220 cm

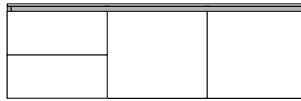

H45 cm · L120-220 cm
H60 cm · L120-220 cm

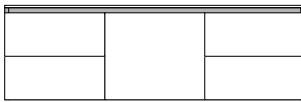

H45 cm · L120-220 cm
H60 cm · L120-220 cm

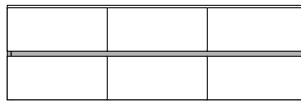

H60 cm · L120-220 cm
H90 cm · L120-180 cm

ES Módulo suspendido abierto. Para modular con cajones y puertas.

IT Modulo sospeso aperto. Per modulare con cassetti e porte.

EN Wall mounted open unit. To be combined with doors and drawers units.

GE Offenes Hängemodul aus Metall. Für die Ergänzung mit Schubladen- und Türmodulen.

FR Niche à suspendre ouvert. À combiner avec tiroirs et portes.

RU Подвесной открытый модуль. Дополняется ящиками и дверцами.

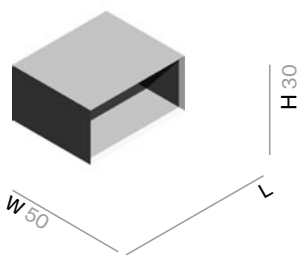

Cod.	H	L	LM/LT	LB	S1	S3/S4
ST952	30	30				
ST1233	30	45				
ST234	30	60				
ST953	30	80				
ST954	30	100				
ST955	30	120				
ST956	30	140				

ES Módulo abierto suspendido o al suelo con un estante.

IT Modulo aperto sospeso o al pavimento con un ripiano.

EN Wall mounted / floor standing open unit with shelf.

GE Offenes Hänge- oder Bodenmodul. Mit Regalbodens.

FR Niche ouverte à suspendre ou au sol avec étagère.

RU Внешняя подвеска или напольный модуль. С полкой.

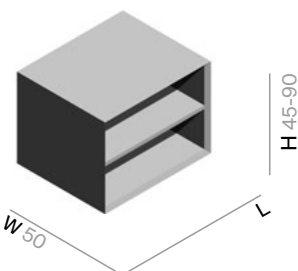

Cod.	H	L	LM/LT	LB	S1	S3/S4
ST201	45	30				
ST202	45	40				
ST203	45	60				
ST204	45	80				
ST957	45	90				
ST958	45	100				
ST959	45	110				
ST206	60	30				
ST207	60	40				
ST208	60	60				
ST209	60	80				
ST983	60	90				
ST984	60	100				
ST985	60	110				

LM Laca Mate / Matt Lacquer / Laqué Mat / Laccato Opaco / Mattlack / Матовый лак

S1 Madera natural / Natural wood / Bois Naturel / Legno Naturale / Echtholz / Натуральное дерево

LT Laca Texturizada / Textured Lacquer / Laqué Texturé / Laccato Testurizzato / Strukturlack / Текстурированный лак

S3 Roble salvaje / Wild oak / Chêne sauvage / Rovere selvaggio / Natureiche / Дикая дуб

LB Laca Brillo / Glossy Lacquer / Laqué Brillant / Lacca Lucida / Glanzlack / Глянцевая медь

S4 Roble Raw / Raw oak / Chêne Raw / Rovere Raw / Roheiche / Raw дуб

ES Módulo suspendido con cajón superior y hueco abierto inferior.

IT Modulo sospeso con cassetto e cavità diafana.

EN Wall mounted unit with drawer and open compartment.

GE Hängemodul mit Schublade und Einzelfach.

FR Meuble à suspendre avec tiroir et espace ouvert.

RU Подвесной модуль с верхним ящиком и нишей.

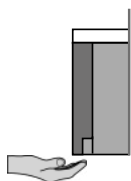
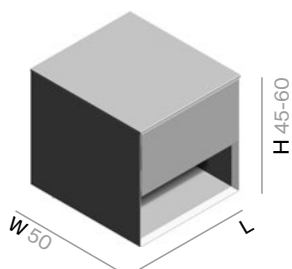

Cod.	H	L	LM/LT	LB	S1	S3/S4
ST239	45	45				
ST243	45	60				
ST864	45	80				
ST960	45	90				
ST961	45	100				
ST962	45	110				
ST246	60	45				
ST248	60	60				
ST869	60	80				
ST986	60	90				
ST987	60	100				
ST988	60	110				

LM Laca Mate / Matt Lacquer / Laqué Mat / Laccato Opaco / Mattlack / Матовый лак

S1 Madera natural / Natural wood / Bois Naturel / Legno Naturale / Echtholz / Натуральное дерево

LT Laca Texturizada / Textured Lacquer / Laqué Texturé / Laccato Testurizzato / Strukturlack / Текстурированный лак

S3 Roble salvaje / Wild oak / Chêne sauvage / Rovere selvaggio / Natureiche / Дикая дуб

LB Laca Brillo / Glossy Lacquer / Laqué Brillant / Lacca Lucida / Glanzlack / Глянцевая медь

S4 Roble Raw / Raw oak / Chêne Raw / Rovere Raw / Roheiche / Raw дуб

ES Módulo suspendido o al suelo con cajón.

IT Modulo sospeso / al pavimento con cassetto.

EN Wall mounted or floor standing unit with drawer.

GE Hänge- oder Bodenmodul mit Schublade.

FR Meuble à suspendre / au sol avec tiroir.

RU Подвесной или напольный модуль с ящиком.

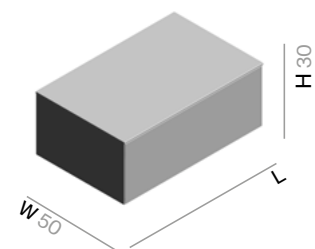

Cod.	H	L	LM/LT	LB	S1	S3/S4
ST731	30	30				
ST732	30	40				
ST733	30	60				
ST734	30	80				
ST735	30	100				
ST747	30	120				

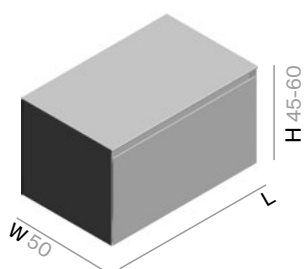
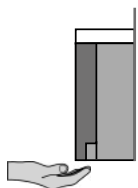

Cod.	H	L	LM/LT	LB	S1	S3/S4
ST322	45	30				
ST312	45	40				
ST316	45	60				
ST319	45	80				
ST701	45	100				
ST773	45	120				

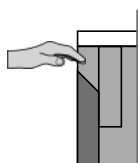

ST727	60	40				
ST728	60	60				
ST729	60	80				
ST730	60	100				

LM Laca Mate / Matt Lacquer / Laqué Mat / Laccato Opaco / Mattlack / Матовый лак

S1 Madera natural / Natural wood / Bois Naturel / Legno Naturale / Echtholz / Натуральное дерево

LT Laca Texturizada / Textured Lacquer / Laqué Texturé / Laccato Testurizzato / Strukturlack / Текстурированный лак

S3 Roble salvaje / Wild oak / Chêne sauvage / Rovere selvaggio / Natureiche / Дикая дуб

LB Laca Brillo / Glossy Lacquer / Laqué Brillant / Lacca Lucida / Glanzlack / Глянцевая медь

S4 Roble Raw / Raw oak / Chêne Raw / Rovere Raw / Roheiche / Raw дуб

ES Módulo suspendido o al suelo con dos cajones.

IT Modulo sospeso o al pavimento con due cassetti.

EN Wall mounted or floor standing unit with two drawers.

GE Hänge- oder Bodenmodul mit zwei Schubladen.

FR Meuble à suspendre ou au sol avec deux tiroirs.

RU Подвесной или напольный модуль с двумя ящиками.

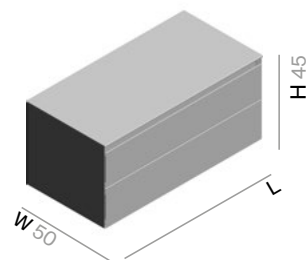

Cod.	H	L	LM/LT	LB	S1	S3/S4
ST337	45	30				
ST325	45	40				
ST327	45	60				
ST329	45	80				
ST702	45	100				
ST746	45	120				

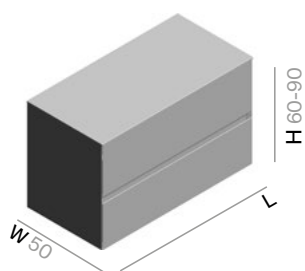
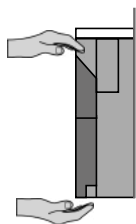

Cod.	H	L	LM/LT	LB	S1	S3/S4
ST707	60	40				
ST708	60	60				
ST709	60	80				
ST712	60	100				
ST761	60	120				

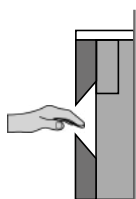

LM Laca Mate / Matt Lacquer / Laqué Mat / Laccato Opaco / Mattlack / Матовый лак

S1 Madera natural / Natural wood / Bois Naturel / Legno Naturale / Echtholz / Натуральное дерево

LT Laca Texturizada / Textured Lacquer / Laqué Texturé / Laccato Testurizzato / Strukturlack / Текстурированный лак

S3 Roble salvaje / Wild oak / Chêne sauvage / Rovere selvaggio / Natureiche / Дикая дуб

LB Laca Brillo / Glossy Lacquer / Laqué Brillant / Lacca Lucida / Glanzlack / Глянцевая медь

S4 Roble Raw / Raw oak / Chêne Raw / Rovere Raw / Roheiche / Raw дуб

ES Módulo suspendido o al suelo con tres cajones.

IT Modulo sospeso o al pavimento con tre cassetti.

EN Wall mounted or floor standing unit with three drawers.

GE Hänge- oder Bodenmodul mit drei Schubladen.

FR Meuble à suspendre ou au sol avec trois tiroirs.

RU Подвесной или напольный модуль с тремя ящиками.

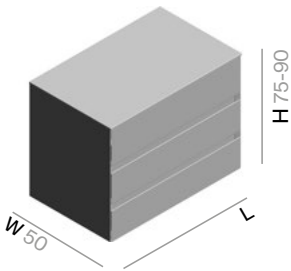

Cod.	H	L	LM/LT	LB	S1	S3/S4
ST818	75/90	40				
ST822	75/90	60				
ST826	75/90	80				
ST830	75/90	100				
ST833	75/90	120				

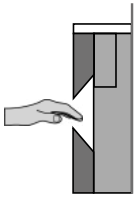

LM Laca Mate / Matt Lacquer / Laqué Mat / Laccato Opaco / Mattlack / Матовый лак

S1 Madera natural / Natural wood / Bois Naturel / Legno Naturale / Echtholz / Натуральное дерево

LT Laca Texturizada / Textured Lacquer / Laqué Texturé / Laccato Testurizzato / Strukturlack / Текстурированный лак

S3 Roble salvaje / Wild oak / Chêne sauvage / Rovere selvaggio / Natureiche / Дикая дуб

LB Laca Brillo / Glossy Lacquer / Laqué Brillant / Lacca Lucida / Glanzlack / Глянцевая медь

S4 Roble Raw / Raw oak / Chêne Raw / Rovere Raw / Roheiche / Raw дуб

ES Módulo compacto suspendido o al suelo con dos cajones.

IT Modulo compatto sospeso o al pavimento con due cassetti.

EN Wall mounted or floor standing unit with two drawers.

GE Kompaktes Hänge- oder Bodenmodul mit zwei Schubladen.

FR Meuble à suspendre ou au sol avec deux tiroirs.

RU Подвесной или напольный компактный модуль с двумя ящиками.

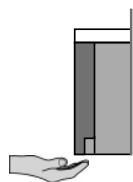
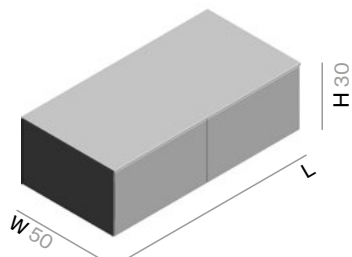

Cod.	H	L	LM/LT	LB	S1	S3/S4
ST767	30	80				
ST768	30	100				
ST769	30	120				
ST770	30	140				
ST771	30	160				
ST772	30	180				
ST1049	30	200				
ST1050	30	220				

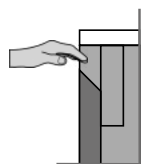
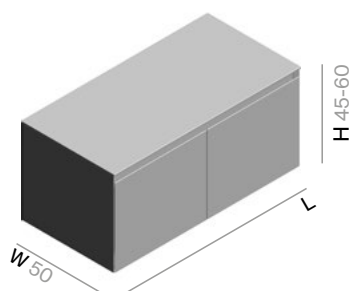

Cod.	H	L	LM/LT	LB	S1	S3/S4
ST500	45	80				
ST705	45	100				
ST706	45	120				
ST744	45	140				
ST745	45	160				
ST756	45	180				
ST1051	45	200				
ST1052	45	220				
ST786	60	80				
ST788	60	100				
ST789	60	120				
ST790	60	140				
ST791	60	160				
ST792	60	180				
ST1069	60	200				
ST1070	60	220				

LM Laca Mate / Matt Lacquer / Laqué Mat / Laccato Opaco / Mattlack / Матовый лак

S1 Madera natural / Natural wood / Bois Naturel / Legno Naturale / Echtholz / Натуральное дерево

LT Laca Texturizada / Textured Lacquer / Laqué Texturé / Laccato Testurizzato / Strukturlack / Текстурированный лак

S3 Roble salvaje / Wild oak / Chêne sauvage / Rovere selvaggio / Natureiche / Дикая дуб

LB Laca Brillo / Glossy Lacquer / Laqué Brillant / Lacca Lucida / Glanzlack / Глянцевая медь

S4 Roble Raw / Raw oak / Chêne Raw / Rovere Raw / Roheiche / Raw дуб

ES Módulo compacto suspendido o al suelo con tres cajones.

IT Modulo compatto sospeso o al pavimento con tre cassetti.

EN Wall mounted or floor standing unit with three drawers.

GE Kompaktes Hänge- oder Bodenmodul mit zwei Schubladen.

FR Meuble à suspendre ou au sol avec trois tiroirs.

RU Подвесной или напольный компактный модуль с тремя ящиками.

 REVERSIBLE

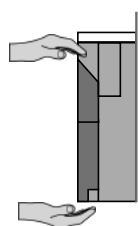
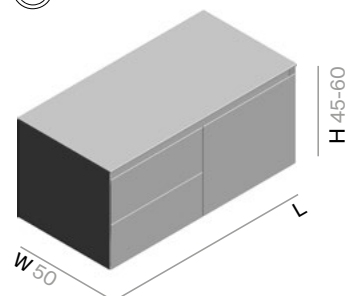

Cod.	H	L	LM/LT	LB	S1	S3/S4
ST501	45	80				
ST509	45	100				
ST508	45	120				
ST742	45	140				
ST743	45	160				
ST757	45	180				
ST1053	45	200				
ST1054	45	220				
ST793	60	80				
ST795	60	100				
ST796	60	120				
ST797	60	140				
ST798	60	160				
ST799	60	180				
ST1071	60	200				
ST1072	60	220				

LM Laca Mate / Matt Lacquer / Laqué Mat / Laccato Opaco / Mattlack / Матовый лак

S1 Madera natural / Natural wood / Bois Naturel / Legno Naturale / Echtholz / Натуральное дерево

LT Laca Texturizada / Textured Lacquer / Laqué Texturé / Laccato Testurizzato / Strukturlack / Текстурированный лак

S3 Roble salvaje / Wild oak / Chêne sauvage / Rovere selvaggio / Natureiche / Дикая дуб

LB Laca Brillo / Glossy Lacquer / Laqué Brillant / Lacca Lucida / Glanzlack / Глянцевая медь

S4 Roble Raw / Raw oak / Chêne Raw / Rovere Raw / Roheiche / Raw дуб

ES Módulo compacto suspendido o al suelo con cuatro cajones.

IT Modulo compatto sospeso o al pavimento con quattro cassetti.

EN Wall mounted or floor standing unit with four drawers.

GE Kompaktes Hänge- oder Bodenmodul mit vier Schubladen.

FR Meuble à suspendre ou au sol avec quatre tiroirs.

RU Подвесной или напольный компактный модуль с четырьмя ящиками.

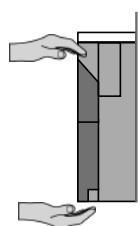
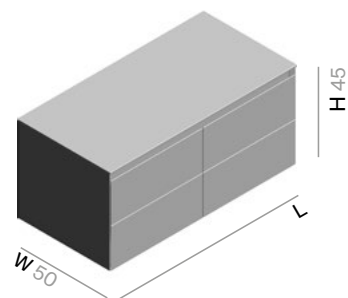

Cod.	H	L	LM/LT	LB	S1	S3/S4
ST748	45	80				
ST751	45	100				
ST752	45	120				
ST754	45	140				
ST755	45	160				
ST758	45	180				
ST1055	45	200				
ST1056	45	220				

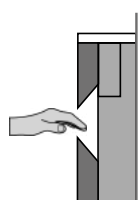
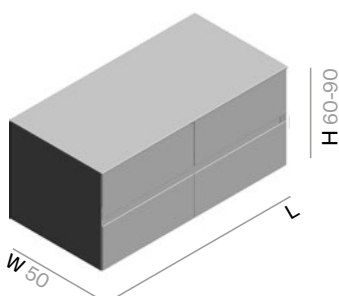

Cod.	H	L	LM/LT	LB	S1	S3/S4
ST736	60	80				
ST738	60	100				
ST739	60	120				
ST740	60	140				
ST741	60	160				
ST764	60	180				
ST1073	60	200				
ST1074	60	220				
ST834	75/90	80				
ST836	75/90	100				
ST837	75/90	120				
ST838	75/90	140				
ST839	75/90	160				
ST841	75/90	180				

LM Laca Mate / Matt Lacquer / Laqué Mat / Laccato Opaco / Mattlack / Матовый лак

S1 Madera natural / Natural wood / Bois Naturel / Legno Naturale / Echtholz / Натуральное дерево

LT Laca Texturizada / Textured Lacquer / Laqué Texturé / Laccato Testurizzato / Strukturlack / Текстурированный лак

S3 Roble salvaje / Wild oak / Chêne sauvage / Rovere selvaggio / Natureiche / Дикая дуб

LB Laca Brillo / Glossy Lacquer / Laqué Brillant / Lacca Lucida / Glanzlack / Глянцевая медь

S4 Roble Raw / Raw oak / Chêne Raw / Rovere Raw / Roheiche / Raw дуб

ES Módulo compacto suspendido o al suelo con tres cajones.

IT Modulo compatto sospeso o al pavimento con tre cassetti.

EN Wall mounted or floor standing unit with three drawers.

GE Kompaktes Hänge- oder Bodenmodul mit drei Schubladen.

FR Meuble à suspendre ou au sol avec trois tiroirs.

RU Подвесной или напольный компактный модуль с тремя ящиками.

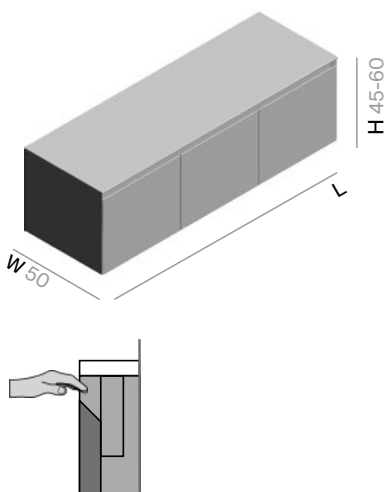

Cod.	H	L	LM/LT	LB	S1	S3/S4
ST774	45	120				
ST775	45	140				
ST776	45	160				
ST777	45	180				
ST1057	45	200				
ST1058	45	220				
ST812	60	120				
ST813	60	140				
ST814	60	160				
ST815	60	180				
ST1075	60	200				
ST1076	60	220				

LM Laca Mate / Matt Lacquer / Laqué Mat / Laccato Opaco / Mattlack / Матовый лак

S1 Madera natural / Natural wood / Bois Naturel / Legno Naturale / Echtholz / Натуральное дерево

LT Laca Texturizada / Textured Lacquer / Laqué Texturé / Laccato Testurizzato / Strukturlack / Текстурированный лак

S3 Roble salvaje / Wild oak / Chêne sauvage / Rovere selvaggio / Natureiche / Дикая дуб

LB Laca Brillo / Glossy Lacquer / Laqué Brillant / Lacca Lucida / Glanzlack / Глянцевая медь

S4 Roble Raw / Raw oak / Chêne Raw / Rovere Raw / Roheiche / Raw дуб

ES Módulo compacto suspendido o al suelo con cuatro cajones.

IT Modulo compatto sospeso o al pavimento con quattro cassetti.

EN Wall mounted or floor standing unit with four drawers.

GE Kompaktes Hänge- oder Bodenmodul mit vier Schubladen.

FR Meuble à suspendre ou au sol avec quatre tiroirs.

RU Подвесной или напольный компактный модуль с четырьмя ящиками.

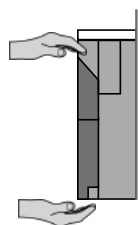
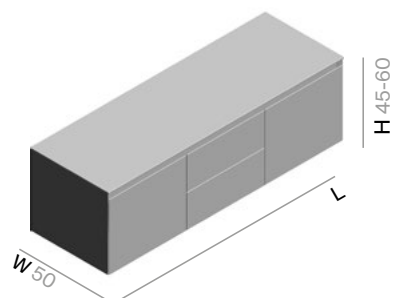

Cod.	H	L	LM/LT	LB	S1	S3/S4
ST778	45	120				
ST779	45	140				
ST780	45	160				
ST781	45	180				
ST1059	45	200				
ST1060	45	220				
ST819	60	120				
ST823	60	140				
ST827	60	160				
ST845	60	180				
ST1077	60	200				
ST1078	60	220				



REVERSIBLE

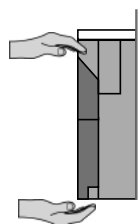
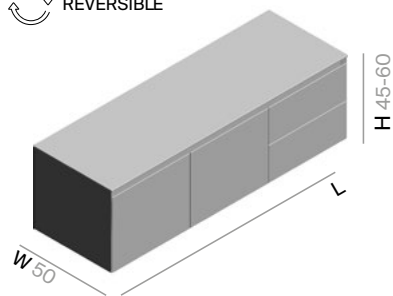

Cod.	H	L	LM/LT	LB	S1	S3/S4
ST969	45	120				
ST970	45	140				
ST971	45	160				
ST972	45	180				
ST1061	45	200				
ST1062	45	220				
ST1200	60	120				
ST1201	60	140				
ST1202	60	160				
ST1203	60	180				
ST1204	60	200				
ST1205	60	220				

LM Laca Mate / Matt Lacquer / Laqué Mat / Laccato Opaco / Mattlack / Матовый лак

S1 Madera natural / Natural wood / Bois Naturel / Legno Naturale / Echtholz / Натуральное дерево

LT Laca Texturizada / Textured Lacquer / Laqué Texturé / Laccato Testurizzato / Strukturlack / Текстурированный лак

S3 Roble salvaje / Wild oak / Chêne sauvage / Rovere selvaggio / Natureiche / Дикая дуб

LB Laca Brillo / Glossy Lacquer / Laqué Brillant / Lacca Lucida / Glanzlack / Глянцевая медь

S4 Roble Raw / Raw oak / Chêne Raw / Rovere Raw / Roheiche / Raw дуб

ES Módulo compacto suspendido o al suelo con cinco cajones.

IT Modulo compatto sospeso o al pavimento con cinque cassetti.

EN Wall mounted or floor standing unit with five drawers.

GE Kompaktes Hänge- oder Bodenmodul mit fünf Schubladen.

FR Meuble à suspendre ou au sol avec cinq tiroirs.

RU Подвесной или напольный компактный модуль с тремя ящиками.

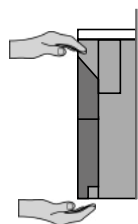
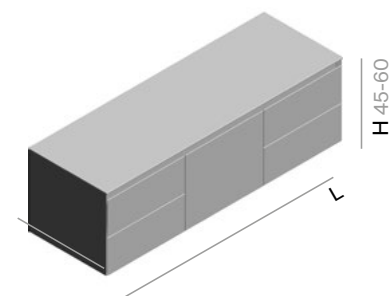

Cod.	H	L	LM/LT	LB	S1	S3/S4
ST977	45	120				
ST978	45	140				
ST979	45	160				
ST980	45	180				
ST1065	45	200				
ST1066	45	220				
ST1212	60	120				
ST1213	60	140				
ST1214	60	160				
ST1215	60	180				
ST1216	60	200				
ST1217	60	220				

ES Módulo compacto al suelo con seis cajones.

IT Modulo compatto al pavimento con sei cassetti.

EN Floor standing unit with six drawers.

GE Kompaktes Bodenmodul mit sechs Schubladen.

FR Meuble au sol avec six tiroirs.

RU Напольный компактный модуль с шестью ящиками.

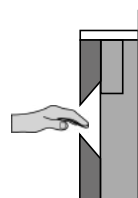
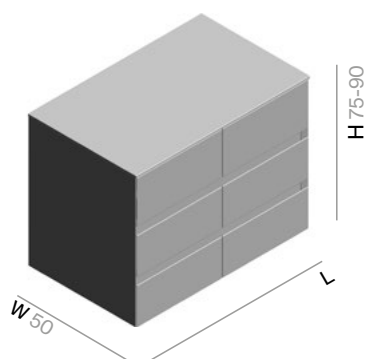

Cod.	H	L	LM/LT	LB	S1	S3/S4
ST875	75/90	80				
ST877	75/90	100				
ST878	75/90	120				
ST879	75/90	140				
ST880	75/90	160				
ST881	75/90	180				

LM Laca Mate / Matt Lacquer / Laqué Mat / Laccato Opaco / Mattlack / Матовый лак

S1 Madera natural / Natural wood / Bois Naturel / Legno Naturale / Echtholz / Натуральное дерево

LT Laca Texturizada / Textured Lacquer / Laqué Texturé / Laccato Testurizzato / Strukturlack / Текстурированный лак

S3 Roble salvaje / Wild oak / Chêne sauvage / Rovere selvaggio / Natureiche / Дикая дуб

LB Laca Brillo / Glossy Lacquer / Laqué Brillant / Lacca Lucida / Glanzlack / Глянцевая медь

S4 Roble Raw / Raw oak / Chêne Raw / Rovere Raw / Roheiche / Raw дуб

ES Módulo suspendido o al suelo con puerta. Dirección apertura de la puerta a elegir. Equipado con estante interior.

IT Modulo sospeso o al pavimento con porta. Direzione di apertura dell'anta a scelta. Dotato di ripiano interno.

EN Wall mounted or floor standing unit with door. You can mount the door to open from the right or left. Inner shelf included.

GE Hänge- oder Bodenmodul mit Tür. Anschlag/Öffnung der Tür nach Wahl. Ausgestattet mit Innenablage.

FR Meuble à suspendre ou au sol avec une porte. Sens d'ouverture de la porte à choisir. Avec étagère intérieure.

RU Подвесной или напольный модуль с дверцей. Направление открытия дверцы на выбор. Внутренняя полка.

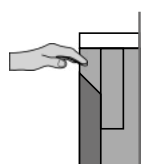
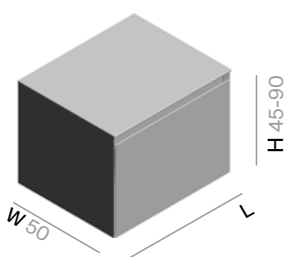

Cod.	H	L	LM/LT	LB	S1	S3/S4
ST323	45	30				
ST311	45	40				
ST981	45	60				
ST324	60	30				
ST313	60	40				
ST995	60	60				
ST843	75/90	30				
ST844	75/90	40				
ST632	75/90	60				

ES Módulo suspendido o al suelo con dos puertas. Equipado con estante interior.

IT Modulo sospeso o al pavimento con due porte. Dotato di ripiano interno.

EN Wall mounted or floor standing unit with two doors. Inner shelf included.

GE Hänge- oder Bodenmodul mit zwei Türen. Ausgestattet mit Innenablage.

FR Meuble à suspendre ou au sol avec deux portes. Avec étagère intérieure.

RU Подвесной или напольный модуль с двумя дверцами. Внутренняя полка.

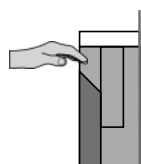
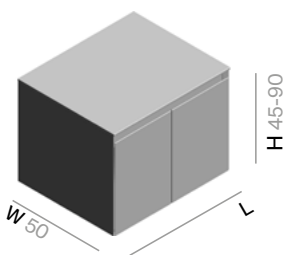

Cod.	H	L	LM/LT	LB	S1	S3/S4
ST314	45	60				
ST321	45	80				
ST704	45	100				
ST982	45	120				
ST317	60	60				
ST320	60	80				
ST713	60	100				
ST996	60	120				
ST846	75/90	60				
ST847	75/90	80				
ST848	75/90	100				
ST633	75/90	120				

LM Laca Mate / Matt Lacquer / Laqué Mat / Laccato Opaco / Mattlack / Матовый лак

S1 Madera natural / Natural wood / Bois Naturel / Legno Naturale / Echtholz / Натуральное дерево

LT Laca Texturizada / Textured Lacquer / Laqué Texturé / Laccato Testurizzato / Strukturlack / Текстурированный лак

S3 Roble salvaje / Wild oak / Chêne sauvage / Rovere selvaggio / Natureiche / Дикая дуб

LB Laca Brillo / Glossy Lacquer / Laqué Brillant / Lacca Lucida / Glanzlack / Глянцевая медь

S4 Roble Raw / Raw oak / Chêne Raw / Rovere Raw / Roheiche / Raw дуб